

3/8" = 9/16" hex
 5/16" = 1/2" hex
 1/4" = 7/16" hex
 #10 = 3/8" hex

Starter = 12 mm hex
 Engine ground =
 M8, 1/2" hex

DC Panel

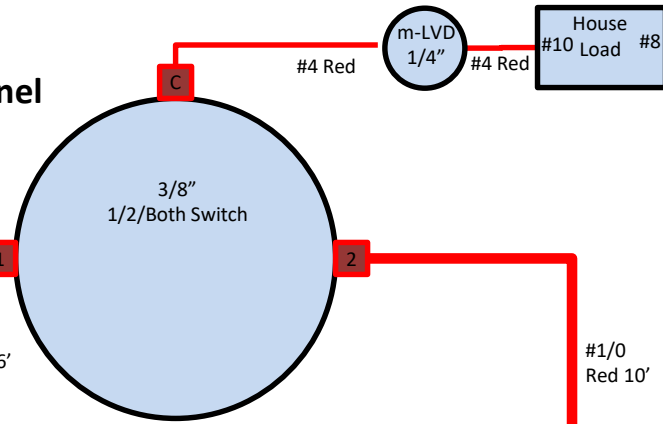

Engine Compartment



Lazarette

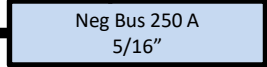
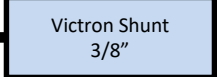
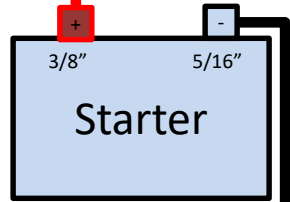
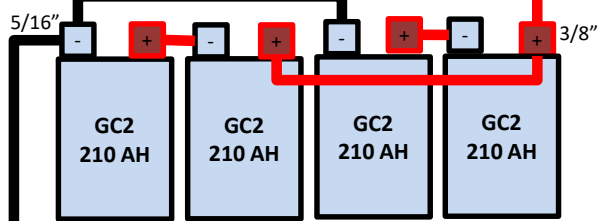
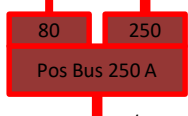
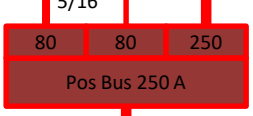
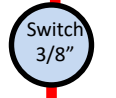
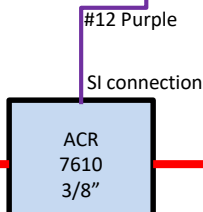
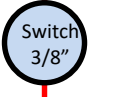
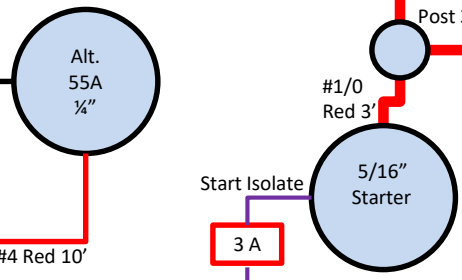
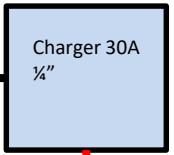

Battery Compartment

